



History-Based Value Report

\$26,880 CARFAX Retail Value

History events affecting this vehicle's value

↑

 1-Owner Vehicle

↑

 Service History

↓

 Rebuilt Brand

↓

 Airbag Deployed





Vehicle History Report

2023 HONDA CIVIC SPORT TOURING

VIN: 19XFL1H8XPE008545
 HATCHBACK 4 DR
 1.5L I4
 GASOLINE
 FRONT WHEEL DRIVE

 Branded Title: Rebuilt

 2 Service history records

 At least 1 open recall

 CARFAX 1-Owner vehicle

 Personal lease vehicle

 978 Last reported odometer reading

This CARFAX Vehicle History Report is based only on information supplied to CARFAX and available as of 11/2/24 at 12:29:50 PM (CDT). Other information about this vehicle, including problems, may not have been reported to CARFAX. Use this report as one important tool, along with a vehicle inspection and test drive, to make a better decision about your next used car.



Accident / Damage History

Not all accidents / issues are reported to CARFAX

Event 1

06/24/2023

Accident reported

- It hit a stationary object
- It hit a sign
- It hit a tree
- Vehicle towed
- Front airbag deployed

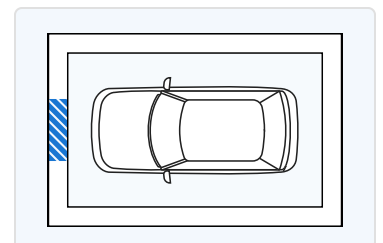



Additional History

Not all accidents / issues are reported to CARFAX

Owner 1

Total Loss

No total loss reported to CARFAX.

✓ No Issues Reported

Structural Damage

CARFAX recommends that you have this vehicle inspected by a collision repair specialist.

✓ No Issues Reported

Airbag Deployment

Airbag deployment reported: 06/24/2023.

Airbag Deployment

Odometer Check

No indication of an odometer rollback.

✓ No Issues Indicated

Accident / Damage

DMV title problems reported. Accident reported: 06/24/2023.

Severe Damage

Manufacturer Recall

At least 1 manufacturer recall requires service. Locate an authorized Honda dealer to obtain more information about this recall.

Recall Reported

Basic Warranty

Original manufacturer warranty likely voided by manufacturer.

Warranty Voided



Title History

Owner 1

Damage Brands

Salvage | Junk | Rebuilt | Fire | Flood | Hail | Lemon

Alert!
Problem Found

Odometer Brands

Not Actual Mileage | Exceeds Mechanical Limits

No Problem



ALERT! - Severe problems were reported by a state Department of Motor Vehicles (DMV). This vehicle does not qualify for the CARFAX Buyback Guarantee.



Ownership History

The number of owners is estimated

Owner 1

Year purchased

2023

Type of owner

Personal lease



Estimated length of ownership

1 yr. 4 mo.

| | |
|---|------------|
| Owned in the following states/provinces | Washington |
| Estimated miles driven per year | — |
| Last reported odometer reading | 978 |

CARFAX Detailed History

 **Owner 1** Personal Lease Vehicle
Purchased: 2023

| Date | Mileage | Source | Comments |
|------------|---------|---|--|
| 05/24/2023 | 2 | West Hills Honda Bremerton, WA 360-377-1100 westhillshonda.com ★ 4.6 / 5.0 692 Verified Reviews ❤️ 9,570 Customer Favorites |  Vehicle serviced - Pre-delivery inspection completed - VIN glass etching vin etched - Accessories installed - Body side moldings installed - Door edge guards installed - Carpet protection installed |
| 06/07/2023 | 46 | West Hills Honda Bremerton, WA 360-377-1100 westhillshonda.com ★ 4.6 / 5.0 692 Verified Reviews ❤️ 9,570 Customer Favorites | Vehicle sold |
| 06/20/2023 | | Washington Motor Vehicle Dept. Port Orchard, WA Title #1866203242 | Title issued or updated - First owner reported - Titled or registered as personal lease vehicle - Vehicle color noted as Black |
| 06/24/2023 | | Damage Report |  Accident reported - It hit a stationary object - It hit a sign - It hit a tree - Damage to front - Vehicle towed - Front airbag deployed CARFAX Airbag Tips |

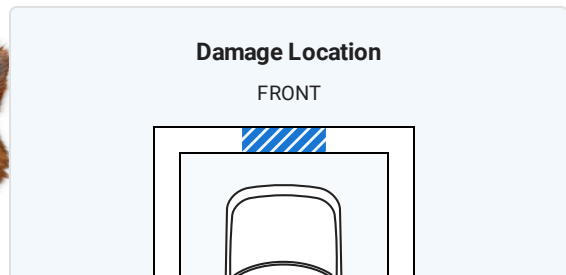

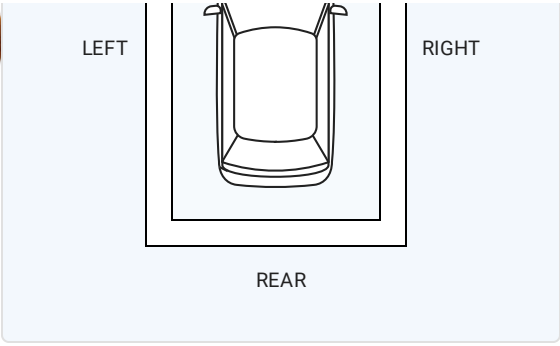

ACCIDENT & DAMAGE INFORMATION

| | | | |
|----------------|---|--|--|
| 07/13/2023 | Washington Motor Vehicle Dept. Port Orchard, WA Title #1866203242 | | REBUILT TITLE ISSUED - Vehicle color noted as Black |
| 08/14/2023 | Washington Motor Vehicle Dept. Port Orchard, WA Title #1866203242 | | Vehicle purchase reported - Dealer took title of this vehicle while it was in inventory - REBUILT TITLE ISSUED - Vehicle color noted as Black |
| 10/20/2023 | American Honda Motor Co. | | Manufacturer Safety-related recall issued - NHTSA #23V-704 - Recall #YFW 2022-24 Civic EPS Inspect Safety Recall (Serv Parts) - Status: Remedy Available Locate an authorized Honda dealer to obtain more information about this recall ⊕ Learn more about this recall |
| 12/14/2023 | Freeway Honda Santa Ana, CA 714-547-3555 freewayhonda.com ★ 4.4 / 5.0 459 Verified Reviews ❤️ 10,389 Customer Favorites | | Vehicle serviced - Maintenance inspection completed |
| 04/17/2024 978 | California Inspection Station | | Passed emissions inspection |
| 10/08/2024 | American Honda Motor Co. | | Manufacturer Safety-related recall issued - NHTSA #24V-744 - Recall #SJS 2022-25 Civic EPS Grbx Greasing Saf Rec - Status: Remedy Available |

Locate an authorized Honda dealer to obtain more information about this recall

⊕ [Learn more about this recall](#)

Have Questions? Consumers, please visit our Help Center at www.carfax.com . Dealers or Subscribers, please visit our Help Center at www.carfaxonline.com .



Glossary

Accident Indicator

CARFAX receives information about accidents in all 50 states, the District of Columbia and Canada.

Not every accident is reported to CARFAX. As details about the accident become available, those additional details are added to the CARFAX Vehicle History Report. CARFAX recommends that you have this vehicle inspected by a qualified mechanic.

- According to the National Safety Council, Injury Facts, 2021 edition, 5% of the 276 million registered vehicles in the U.S. were involved in an accident in 2019. Over 77% of these were considered minor or moderate.
- This CARFAX Vehicle History Report is based only on information supplied to CARFAX and available as of 11/2/24 at 12:29:50 PM (CDT). Other information about this vehicle, including problems, may not have been reported to CARFAX. Use this report as one important tool, along with a vehicle inspection and test drive, to make a better decision about your next used car.

Airbag Deployment

Occurs when the driver, passenger or side airbag has been used or deployed during a crash or other incident. If an airbag has been deployed, it must be replaced by a qualified technician. Have this car inspected by a mechanic prior to purchase.

First Owner

When the first owner(s) obtains a title from a Department of Motor Vehicles as proof of ownership.

Manufacturer Recall

Automobile manufacturers issue recall notices to inform vehicle owners of a safety defect or failure to meet minimum federal safety or emissions standards. Manufacturer recalls are repaired at no cost to the customer.

Ownership History

CARFAX defines an owner as an individual or business that possesses and uses a vehicle. Not all title transactions represent changes in ownership. To provide estimated number of owners, proprietary technology analyzes all the events in a vehicle history. Estimated ownership is available for vehicles manufactured after 1991 and titled solely in the US including Puerto Rico. Dealers sometimes opt to take ownership of a vehicle and are required to in the following states: Maine, Massachusetts, New Jersey, Ohio, Oklahoma, Pennsylvania and South Dakota. Please consider this as you review a vehicle's estimated ownership history.

Rebuilt/Reconstructed Title

A Rebuilt/Reconstructed vehicle is a salvage vehicle that has been repaired and restored to operation. These vehicles are often severely damaged before they are rebuilt and refurbished parts are typically used during reconstruction. In most states, an inspection of the vehicle is required before the vehicle is allowed to return to the road.

Title Issued

A state issues a title to provide a vehicle owner with proof of ownership. Each title has a unique number. Each title or registration record on a CARFAX report does not necessarily indicate a change in ownership. In Canada, a registration and bill of sale are used as proof of ownership.

Follow Us:

facebook.com/CARFAX

[@CARFAXinc](https://twitter.com/CARFAXinc)



[About CARFAX](#)

CARFAX DEPENDS ON ITS SOURCES FOR THE ACCURACY AND RELIABILITY OF ITS INFORMATION. THEREFORE, NO RESPONSIBILITY IS ASSUMED BY CARFAX OR ITS AGENTS FOR ERRORS OR OMISSIONS IN THIS REPORT. CARFAX FURTHER EXPRESSLY DISCLAIMS ALL WARRANTIES, EXPRESS OR IMPLIED, INCLUDING ANY IMPLIED WARRANTIES OF MERCHANTABILITY OR FITNESS FOR A PARTICULAR PURPOSE.

© 2024 CARFAX, Inc., part of S&P Global. All rights reserved.
11/2/24 12:29:50 PM (CDT)

I have reviewed and received a copy of the CARFAX Vehicle History Report for this 2023 HONDA CIVIC vehicle (VIN: 19XFL1H8XPE008545), which is based on information supplied to CARFAX and available as of 11/2/24 at 1:29 PM (EDT).

Customer Signature

Date

Dealer Signature

Date